

Limitag V6 SPOT Multi-block

Modular solutions



Industrial console



Multiple possibilities for print
head blocks



Customised printing height



Integrated message editor

limitronic.com



Limitag v6 SPOT Multi-block



CHARACTERISTICS

- Opposite faces
- Different heights
- Different lines (independent)
- Native resolution of 180dpi or 360dpi
- Multiple densities and contrasts
- High quality bar codes. GS-1 standard
- Intuitive user environment
- Actual on-screen preview of the message to be printed (WYSIWYG)
- Oil based and UV LED inks
- External hardware message selection
- Integration with post-print bar code reader
- Scripting for full customisation of jobs

ADVANTAGES

- Customisation. Short print runs. Promotions
- Reduction of stock of pre-printed containers
- Practically zero maintenance
- No stoppages to change consumables
- Printing on ramps of any inclination



SPECIFICATIONS

PRINT

Print head resolution:

180 dpi
360 dpi

Speed:

60 m/min @ 360dpi
0.2 - 192 m/min depending on the resolution

Height :

70 mm and 140mm per block to 180 and 360dpi

Maximum length: +100 metres

Densities: 3 levels

Font type:

True Type™, Open Type™ fonts

Character coding: Unicode

Bar codes:

GS-1 standard
EAN/UPC, ITF-14, GS1-128, GS1 Datamatrix,
GS1 QR Code

Printing of variable fields:

Of user (customised fields) and automatic fields (expiry dates, shift codes, counters)

Orientation:

Vertical (side of the product)
Horizontal (top of the product)

ELECTRICS

Power supply:

Selectable by switch
88-132 VAC | 176-264 VAC
47-63 Hz, 600 W (max)

Inputs (per block):

1 x printing signal
1 x encoder

Outputs (per block) :

2 x programmable
2 x status indicators

Communication ports:

1 x RS-232
1 x RS-422 / 485 / 232 (optional)
2 x 1GB Ethernet
1 x USB
1 x Wi-Fi (Optional)

ENVIRONMENTAL

Work environment:

5 - 45 °C (41 - 113 °F)

Protection:

IP 52 (controller)

USER INTERFACE

15" colour touchscreen
Selection of messages with preview
WYSIWYG
Diagnostics
Integrated message editor

COMMUNICATIONS

Own communications protocol
Windows™ Driver
Connectivity with external database and ERP
Remote assistance

OTHER

Weight:

24 kg (console)
5 kg (L70 print head)

Consumables:

Oil based inks
UV LED inks



Colours:

Black
Black (high contrast)
Cyan
Magenta
Yellow
Other (consult)

PRINTABLE PRODUCTS

Porous, glossy, coated cardboard, paper, textiles, wood, plastic, metal, foam, EPS...

OPTIONS

Encoder, post-printing bar code verification, alarm beacons, bar code reader for selecting products, external message selection

Limitag v6 SPOT Multi-block

UV LED

UV LED



Printing immediately sets
Useful, long life span with low maintenance
Energy efficient

FEATURES

- Several heights available
- Instant on/off
- Safety through double activation input
- Adjustable intensity

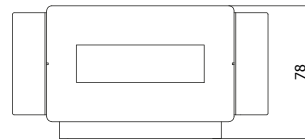
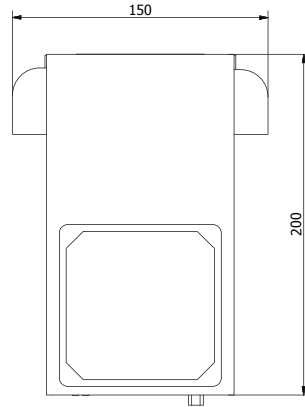

V6 L70 D:
180 dpi
70 mm
DUO

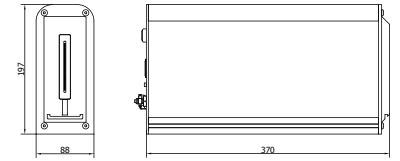
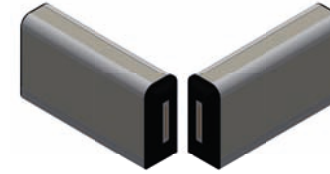

V6 L140 D:
180 dpi
140 mm
DUO

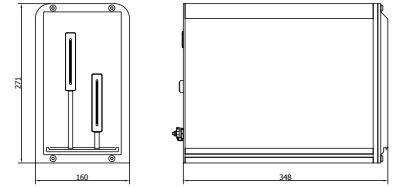
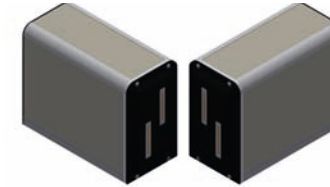

V6 H70 D:
360 dpi
70 mm
DUO

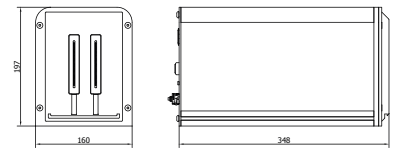
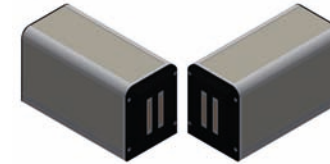

V6 H140:
360 dpi
140 mm

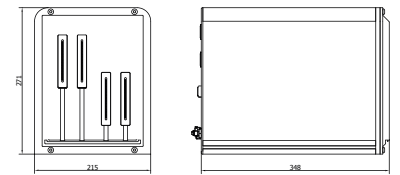

V6 H140 D:
360 dpi
140 mm
DUO

